

Axial Fans WLV Series

- Excellent quality axial fans (EMI).
- Fan frame of highly durable special thermoplastic material (polypropylene colored black).
- For series 50T, 80, and 92 the housing is made of hot-rolled sheet steel, protected by electrostatic epoxy paint (powder coated black).

Impellers:

- Aluminum central hub, stainless steel impeller blades.

Electric motors:

- Aluminum housing (extrusion or die-cast).
- Heat class F insulation. IP55 protection rating.
- Deep groove ball bearings with purpose-developed grease (maintenance-free).
- Single phase motors fitted with built-in thermal overload protection.
- Horizontal or vertical installation.
- Fans include protection guard. Aluminum or plastic gravity grilles available for all fan models.
- In combination with the digital climate control units we can control the humidity, temperature and ventilation.
- Speed controllable.



Applications:

Ideal for greenhouses, animal husbandry units, poultry farms, pork houses, livestock breeding sites and any other agricultural or livestock activities requiring increased resistance ratio conditions. It is also suitable for industries, workshops, car parks, restaurants, large rooms and general foodservices.



WLV 230V / 2800 RPM (2M) Series

Type	Code	RPM	Diameter (mm)	Power (W)	Air flow (m³/h)	Noise Level dB (A)	Price
2S30	WLV 2 / 300	2.800	300	270	3.100	63	€ 651,00
2S35	WLV 2 / 350	2.800	350	415	4.500	67	€ 746,00

WLV 230V / 1400 RPM (4M) Series

Type	Code	RPM	Diameter (mm)	Power (W)	Air flow (m³/h)	Noise Level dB (A)	Price
4S30	WLV 4 / 300	1.400	300	95	2.000	48	€ 561,00
4S35	WLV 4 / 350	1.400	350	120	3.200	49	€ 638,00
4S40	WLV 4 / 400	1.400	400	220	4.700	52	€ 701,00
4S45	WLV 4 / 450	1.400	450	280	6.700	54	€ 754,00
4S50	WLV 4 / 500	1.400	500	385	8.300	56	€ 813,00
4S50T	WLV 4 / 500-T	1.400	500	880	10.800	61	€ 1.271,00
4S56	WLV 4 / 560	1.400	560	530	10.500	65	€ 1.132,00

WLV 230V / 900 RPM (6M) Series

Type	Code	RPM	Diameter (mm)	Power (W)	Air flow (m³/h)	Noise Level dB (A)	Price
6S50	WLV 6 / 500	900	500	140	5.300	42	€ 831,00
6S63	WLV 6 / 630	900	630	530	12.000	57	€ 1.233,00
6S71	WLV 6 / 710	900	710	490	13.800	63	€ 1.432,00

Accessories



WLV Series Performance Curves

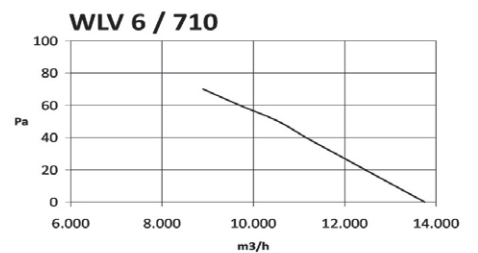
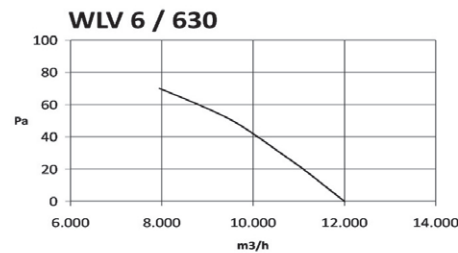
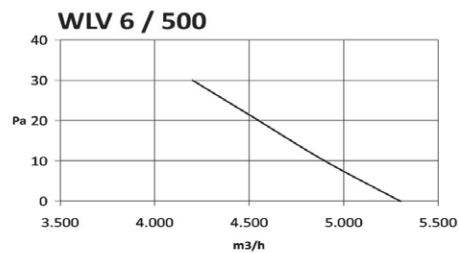
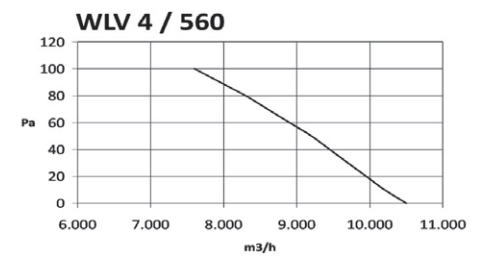
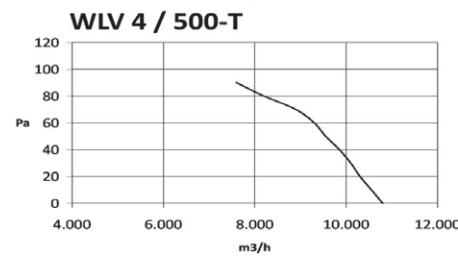
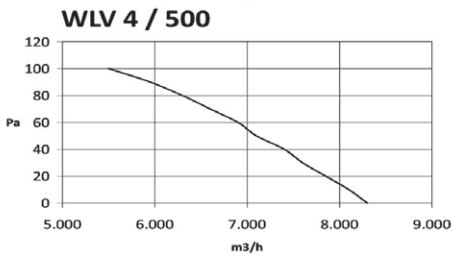
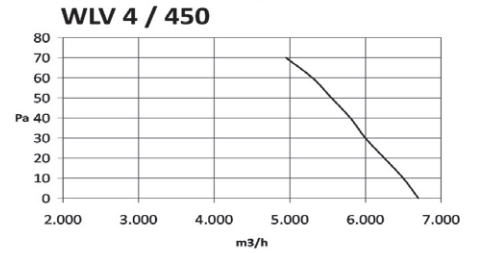
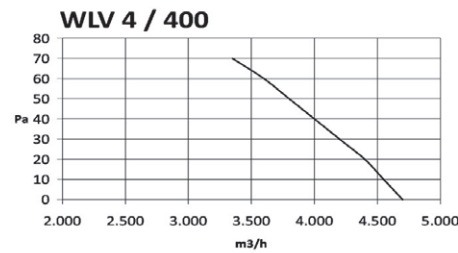
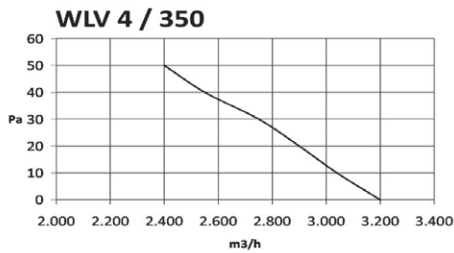
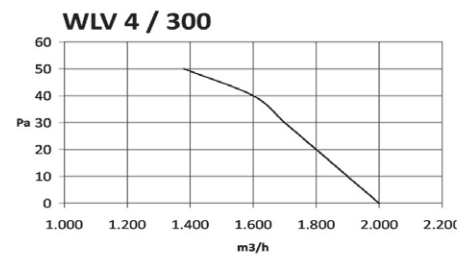
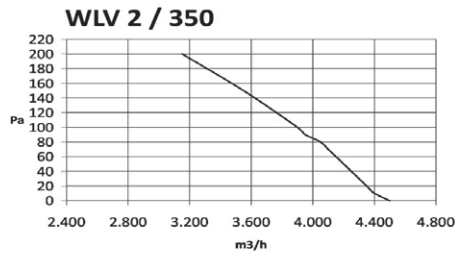
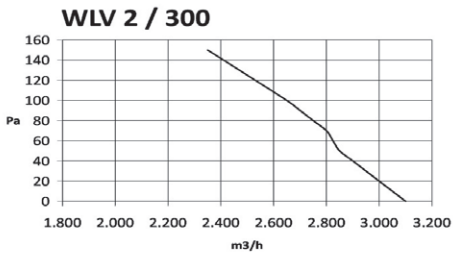

WLV Series Dimensions

Type (cm)	A (mm)	B (mm)	C (mm)	D max (mm)	E (mm)	F (mm)	G (mm)	M η PP*
30	350	395	330	186	106	9,5	20	PP
35	400	445	375	186	106	9,5	20	PP
40	444	495	430	186	106	9,5	20	PP
45	505	575	480	176	116	13	20	PP
50	565	635	535	176	116	13	20	PP
50T	565	635	527	213	133	13	10	M
56	675	760	590	230	106	11	30	PP
63	750	835	660	220	120	11	30	PP
71	810	885	740	230	140	14,5	30	PP

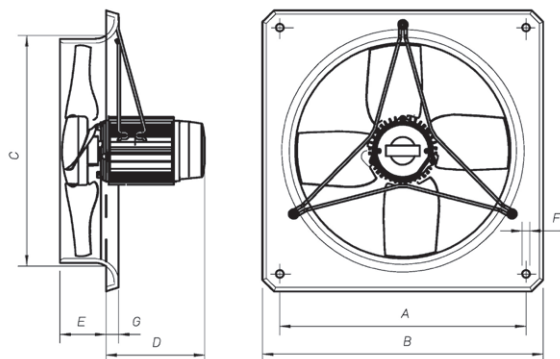

*M Metallic Case, PP Polypropylene Case.